

RPL75

80GHz Radar level transmitter

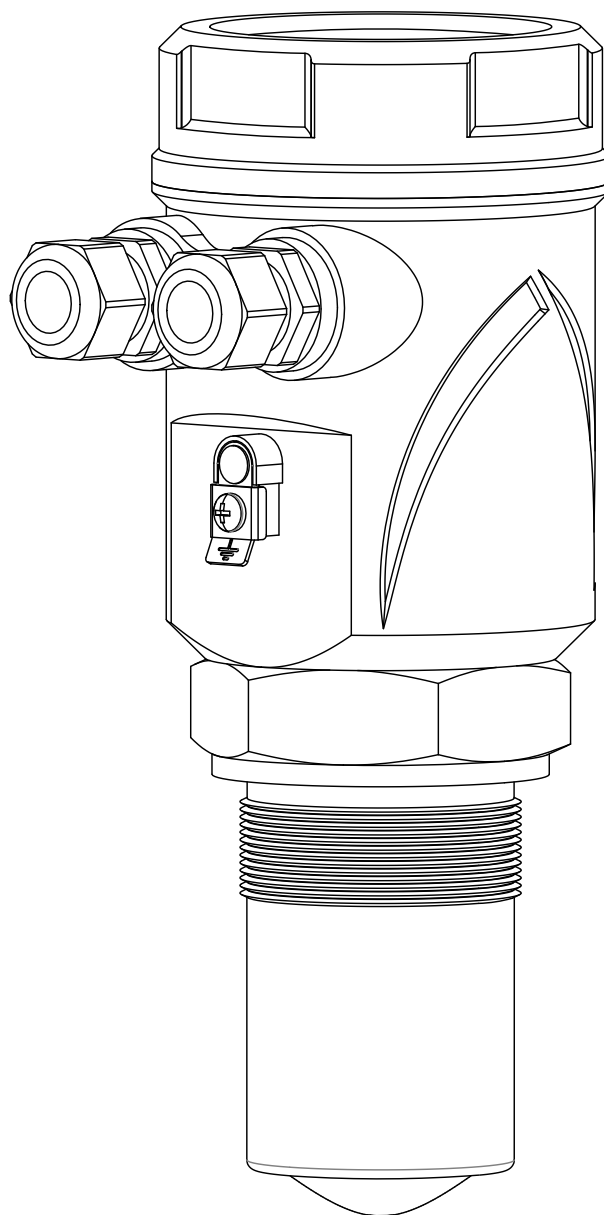

technical documentation EN Rev. of 17/10/2023

CONTENTS

1-WARRANTY	page 3
2-PRODUCT	page 4
3-PERFORMANCE SPECIFICATIONS	page 5
4-DIMENSIONS	page 6
5-INSTALLATION	page 7
6-ELECTRICAL CONNECTIONS	page 10
7-CONFIGURATION MODES	page 11
8-OPERATOR INTERFACE	page 14
9-QUICK SETUP	page 15
10-ADVANCED SETUP	page 22
11-NOTE	page 38
12-FACTORY TEST AND QUALITY CERTIFICATE	page 40

1-WARRANTY

Products supplied by SGM LEKTRA are guaranteed for a period of 12 (twelve) months from delivery date according to the conditions specified in our sale conditions document.

SGM LEKTRA can choose to repair or replace the Product.

If the Product is repaired it will maintain the original term of guarantee, whereas if the Product is replaced it will have 12 (twelve) months of guarantee.

The warranty will be null if the Client modifies, repair or uses the Products for other purposes than the normal conditions foreseen by instructions or Contract.

In no circumstances shall SGM LEKTRA be liable for direct, indirect or consequential or other loss or damage whether caused by negligence on the part of the company or its employees or otherwise howsoever arising out of defective goods

2- PRODUCT

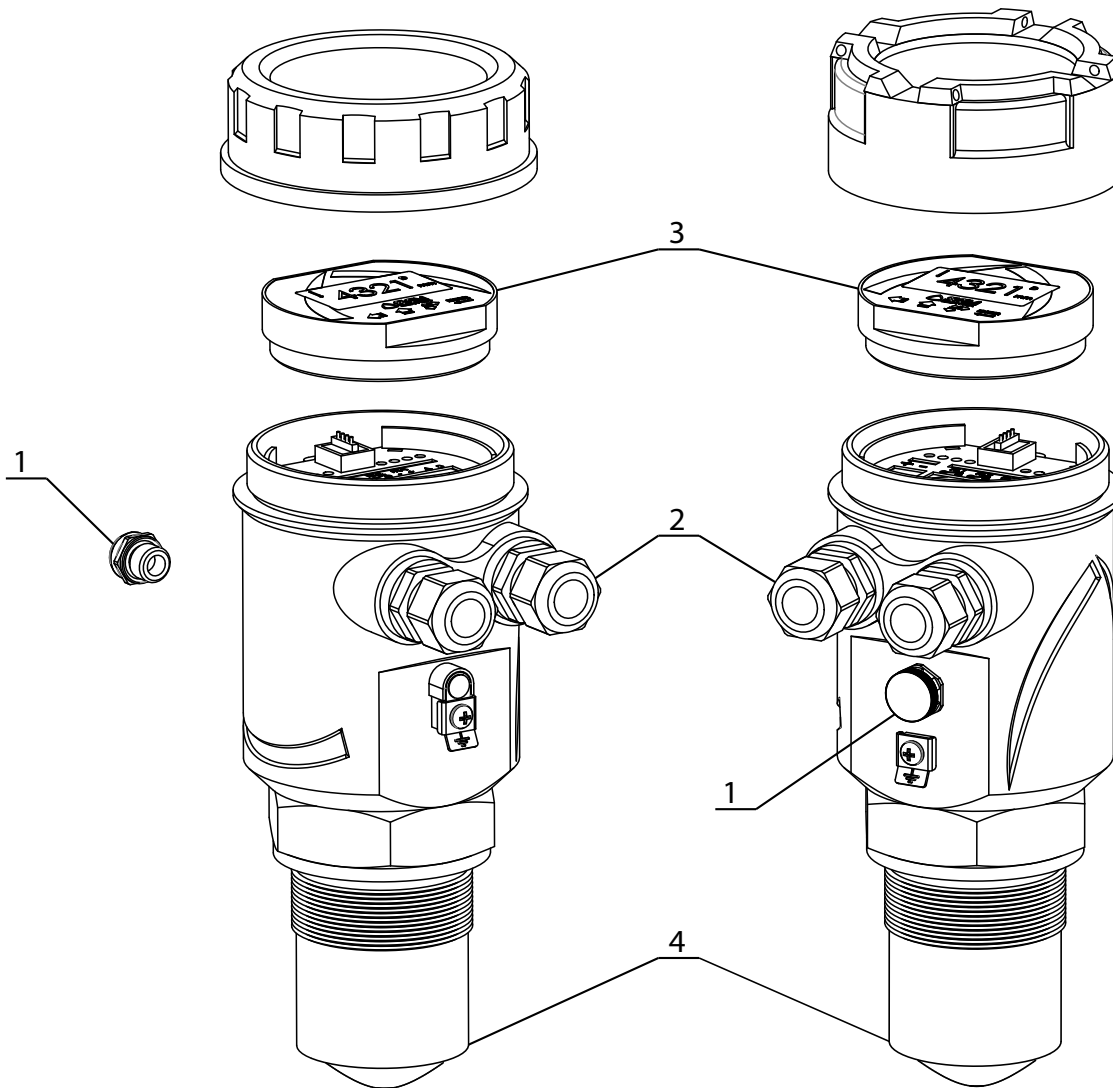

1. Anticondensation filter
2. M20 skintop
3. VL601 (opt.)
4. Sensor

2.1 IDENTIFICATION

Each meter has an adhesive identification plate on which are indicated the meter main data. The following picture describes the information on the identification plate.

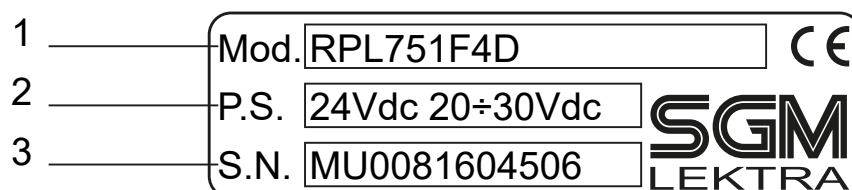

1. Product code

2. Power supply

3. Serial number

3-FEATURES

Housing/sensor material

PC / PP wetted part

Mechanical installation

2" GAS M (Flange in PP DN80 (opt.))

Protection degree

IP67/IP68 (Antenna)

Electrical connection

Internal push connectors

Working temperature

-20 ÷ +60°C

Pressure

Max. 3 bar

Power supply

20÷30Vdc

Power consumption

5W peak; 2,5W average; 0,6W (2 wires)

Analog output

4...20mA, max 750ohm (4 wires)

Relays output

(4 wires only) n°2 3A 230Vac (n.o.) with a resistive load

Digital communication

MODBUS RTU for 4 wires ver.

Max measure range

0.05 ÷ 12mt max for liquids for 2 wires vers.

0.05 ÷ 10mt max for solids

0.05 ÷ 20mt max for liquids

In case of non perfectly reflecting surfaces, the maximum distance value will be reduced

Blind distance

0,05m

Accuracy

Measurement deviation ±5mm, for distances less than 250mm ±10mm.

Resolution

2mm.

Calibration

4 buttons or via MODBUS RTU or Bluetooth

LCD Display

Removable programming module VL601 (opt.) display/keyboard 4 buttons matrix LCD

4-DIMENSIONS

5.1 MECHANICAL DIMENSIONS

PP HOUSING

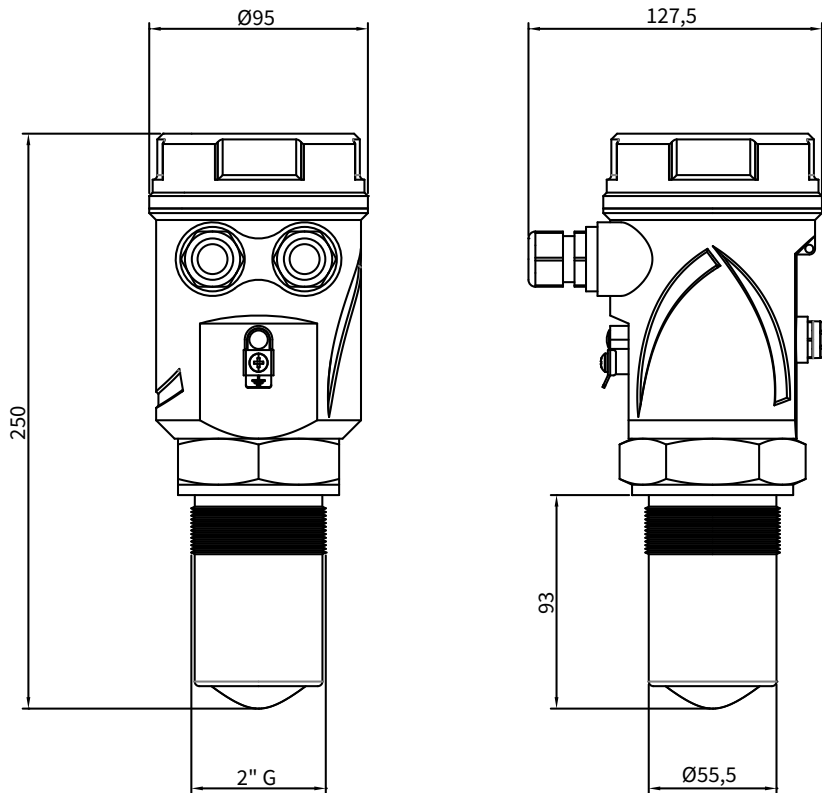

PP HOUSING + EXTENSION

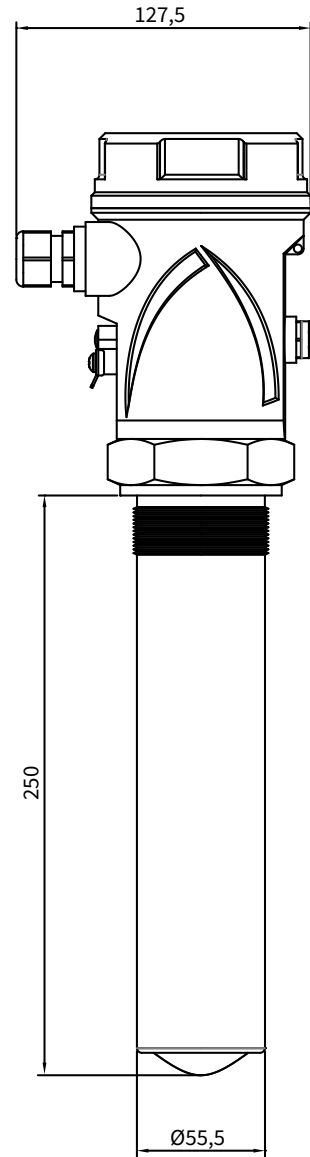

ALUMINIUM HOUSING

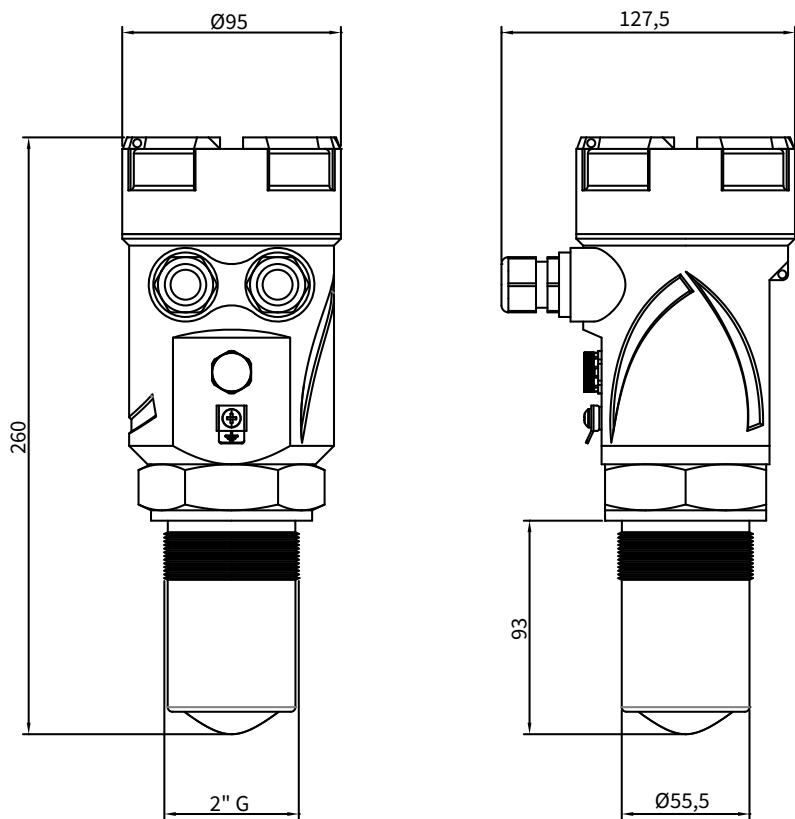

5-INSTALLATION

5.1 MOUNTING PRECAUTIONS

5.1.1 Mounting position

- Leave a 300mm (d) minimum distance between the sensor and the tank smooth wall.
- Use a protective cover to protect the sensor from weather and direct sunlight (c).
- Do not install the sensor near the load zone (a).
- Make sure that in the sensor emission beam (lobe "α") there are no obstacles (f,e) that can be intercepted as level.

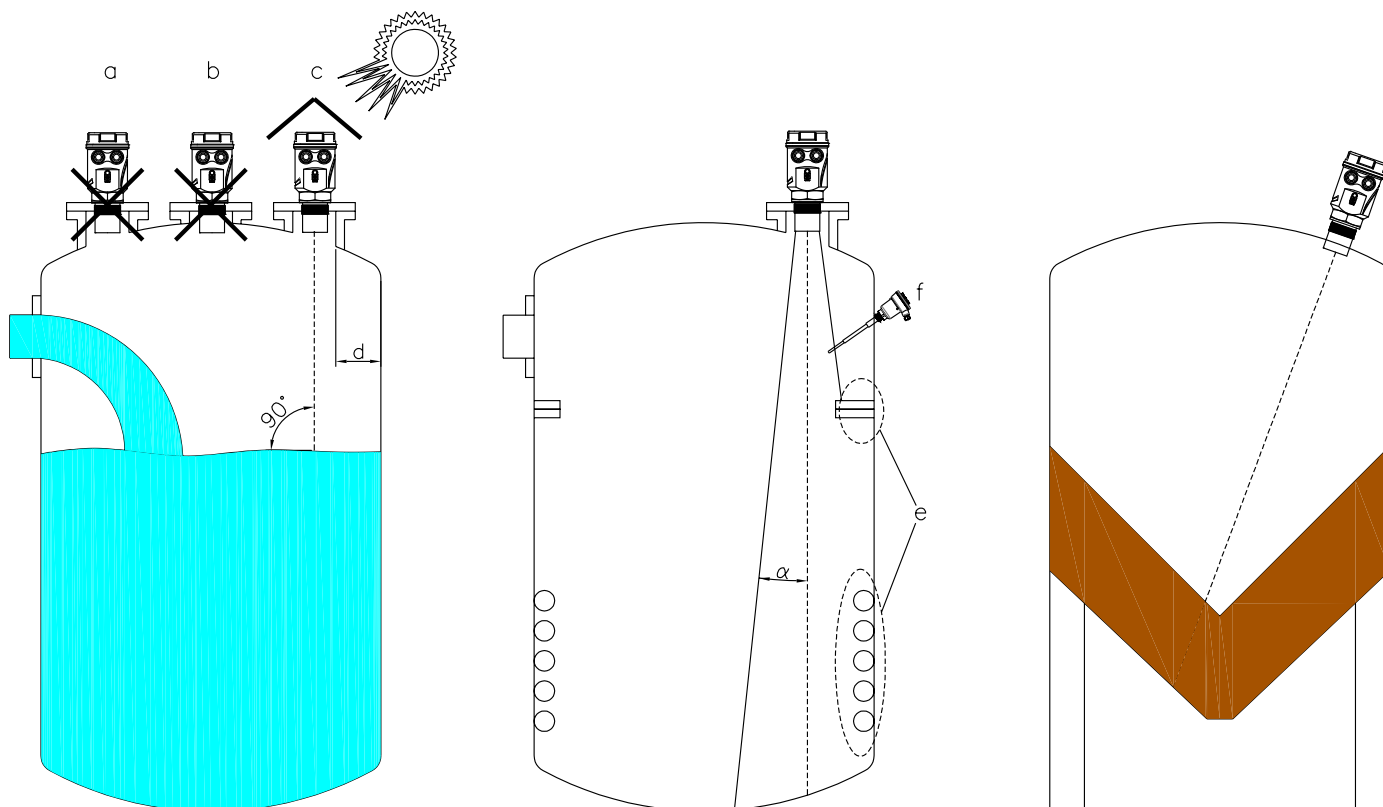

5.1.2 Special European directive

According to EN 302 729, paragraph 4.6.1.3, a minimum distance of 4 km from radio astronomy sites is required, unless special authorization has been provided by the responsible national regulatory authority. Also, at the distance between 4 km and 40 km from any radio astronomy site, the height of the LPR antenna should not exceed 15 m above the ground.

5.1.3 Blind distance

During installation is important to remember that in the sensor proximity there is a blind zone (or BLIND DISTANCE) of 0.05m where the sensor can not measure.

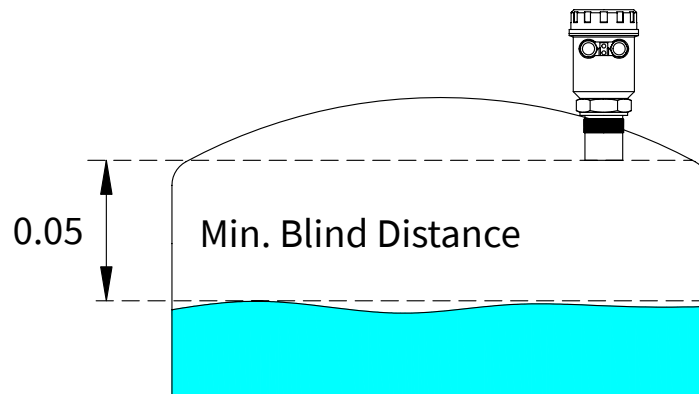

5.1.4 Installation in nozzle

In case of nozzle installation, make sure the sensor bottom protrudes at least 10mm from the bottom of the nozzle.

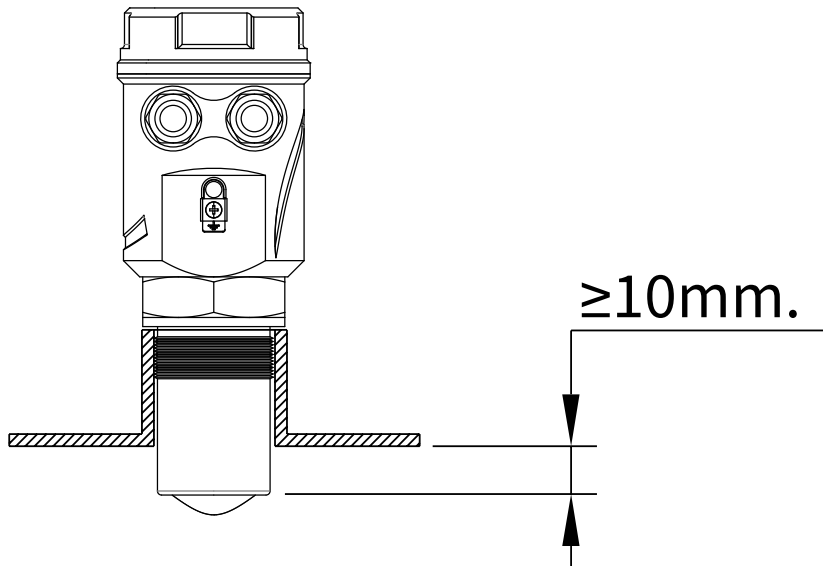

5.1.5 Agitators presence

The level measurement is possible thanks to the Auto-Tuned statistical filter.

Should rarely need to adjust the filter setting by editing 2 RPL75 sensor programming parameters:

- FILTER; this parameter is present in the Quick Setup menu and in the Advanced Configuration “SETUP” menu; increasing the parameter value, decreases the sensor sensitivity to the level measurement sudden variations.
- F-WINDOW; this parameter is present in the Advanced Configuration “SERVICE” menu; decreasing the parameter programmed value, increases the sensor immunity to false echoes.

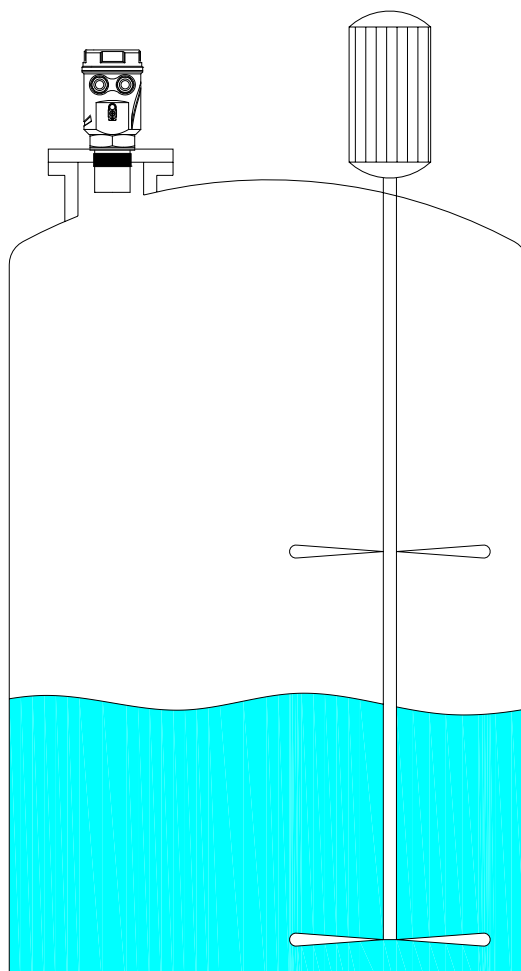

6-ELECTRICAL CONNECTIONS

6.1 WIRING

- 1) Separate the engine control cables or power cables from the RPL75 connection cables.
- 2) Open the cap by unscrewing.
- 3) Lead the cables into the transmitter through the glands.
- 4) Do not use sleeves terminals, because they might interfere with the VL601 module insertion.
- 5) Close the cap and tighten the cable glands.

2-WIRE VERSION

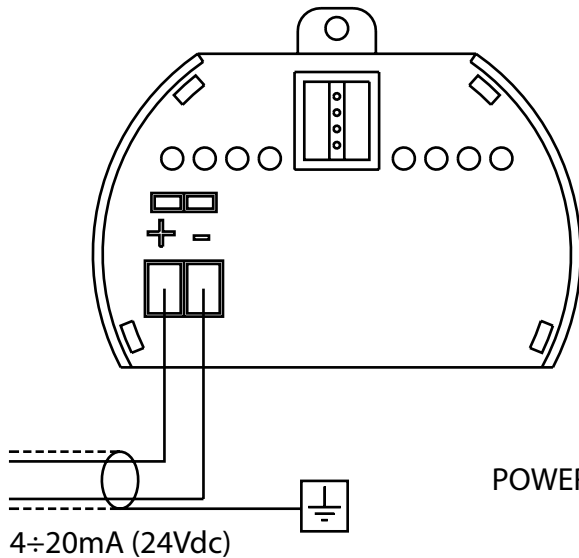

4-WIRE VERSION

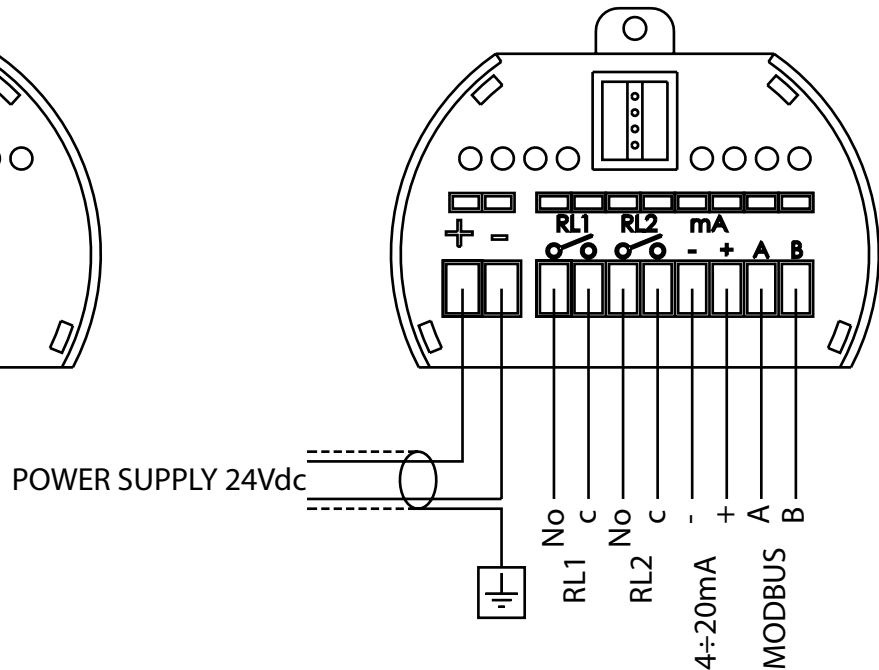

6.2 HUMIDITY INFILTRATIONS

To avoid the humidity infiltration inside the housing is recommended:

- For electrical connections, use a cable with a 6÷12mm outer diameter and fully tighten the M20 cable gland.
- Fully tighten the cap.
- Position the cable so that it forms a downward curve at the M20 output; in this way the condensation and/or rain water will tend to drip from the curve bottom.

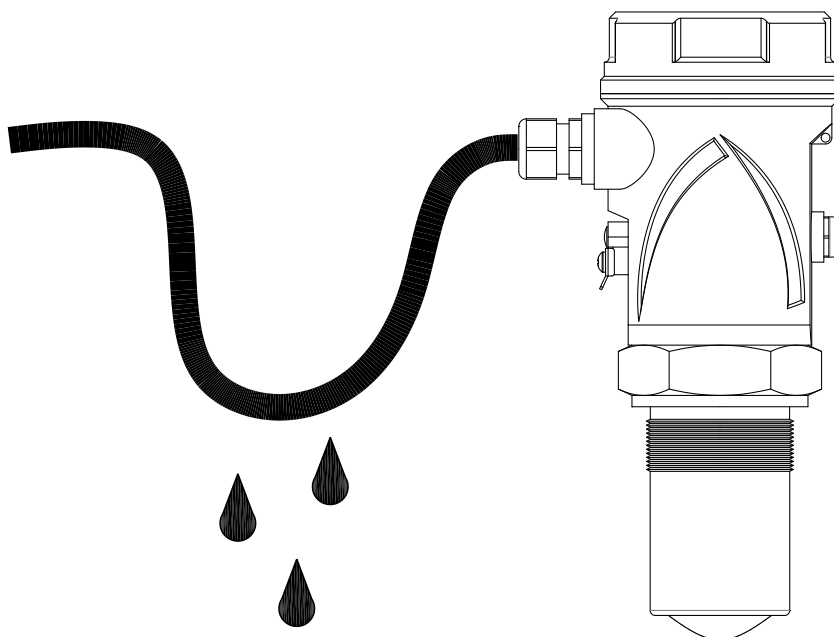

7-CONFIGURATION MODES

The RPL75 have 3 configuration/calibration modes:

- via digital communication: via MODBUS RTU, by PC
- via programming module VL601
- via Bluetooth with Android App

7.1 DIGITAL COMMUNICATIONS CONNECTION

7.1.1 RPL75 MODBUS RTU PC connection

- 1) RPL75 with MODBUS RTU communication protocol.
- 2) USB/RS485 interface module, cod.694A004A.
- 3) MODBUS RTU communication S/W, cod.010F105A, for RPL75 transmitter.

With this software is possible:

- to connect the RPL75 transmitters in MODBUS RTU network by selecting the UID address.
- to read on your PC monitor all measures in reading and RPL75 operation data.
- to program all RPL75 configuration parameters.
- to store the measurement readings and the operating status of RPL75.

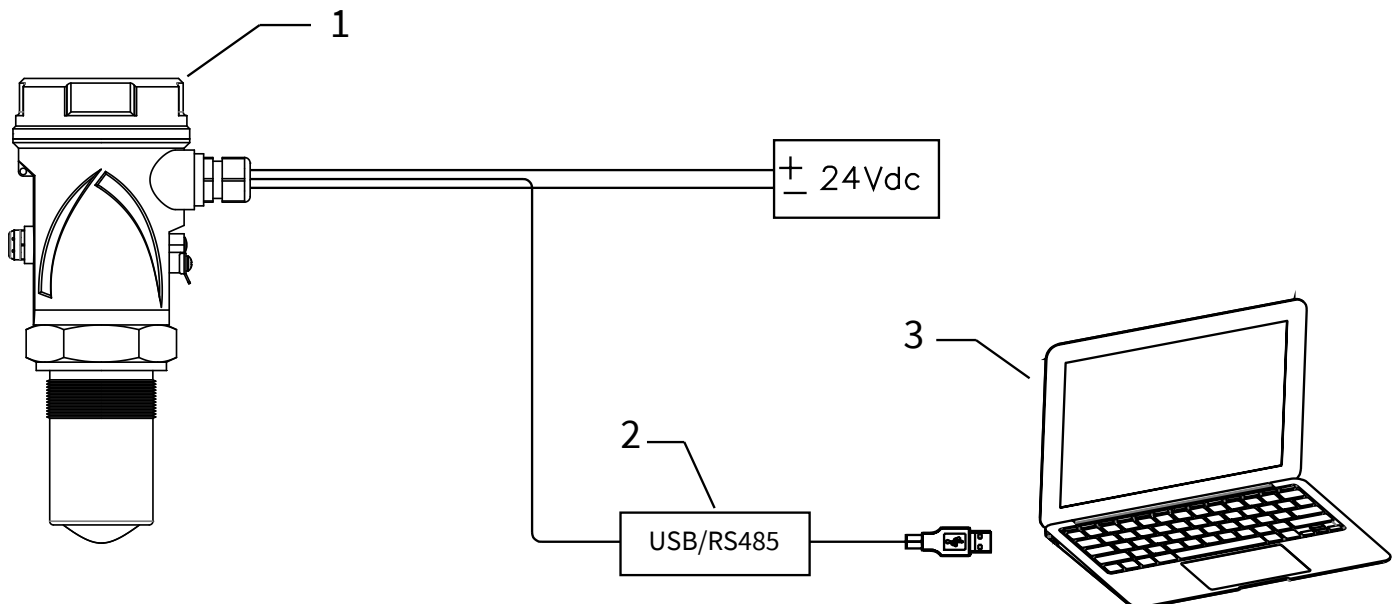

MODBUS REGISTERS FOR RPL75

Address (dec)	Address (hex)	(N°of registers)	Type	Description	Measure unit	R	W	Note
0	0	1	unsigned int	Distance	mm	03h		
1	1	1	unsigned int	Level	mm	03h		
2	2	2	float	Level %	%	03h		
6	6	2	float	Analog output	mA	03h		
10	A	1	unsigned int	Distance 4mA	mm	03h	06h	
11	B	1	unsigned int	Distance 20mA	mm	03h	06h	
14	E	1	unsigned int	Blind distance	mm	03h	06h	
22	16	1	unsigned int	Filter coefficient		03h	06h	
24	18	1	unsigned int	UID		03h	06h	
37	25	1	unsigned int	Delay setpoint RL1	s	03h	06h	
39	27	1	unsigned int	Delay setpoint RL2	s	03h	06h	
42	2A	1	unsigned int	Delay pump control RL1	s	03h	06h	
43	2B	1						
44	2C	1	unsigned int	Alarm mode (MAX/MIN) RL1		03h	06h	0:MAX 1:MIN
45	2D	1	unsigned int	Safety (NO/YES) RL1		03h	06h	0:Norm_disexcited 1:Norm_excited
46	2E	1	unsigned int	Enable RL1		03h	06h	0:disabled 1:enabled
47	2F	1	unsigned int	Alarm mode (MAX/MIN) RL2		03h	06h	0:MAX 1:MIN
48	30	1	unsigned int	Safety (NO/YES) RL2		03h	06h	0:Norm_disexcited 1:Norm_excited
49	31	1	unsigned int	Enable RL2		03h	06h	0:disabled 1:enabled
50	32	1	unsigned int	Pump control mode RL1		03h	06h	0:EMPTYING 1:FILLING
51	33	1	unsigned int	Enable pump control RL1		03h	06h	0:disabled 1:enabled
52	34	1	unsigned int	Enable diagnostic alarm RL2		03h	06h	0:disabled 1:enabled
53	35	1	unsigned int	Measurement return power		03h	06h	0...32767
54	36	1						









MODBUS REGISTERS FOR RPL75

Address (dec)	Address (hex)	(N° of registers)	Type	Description	Measure unit	R	W	Note
55	37	1	unsigned int	Echo error		03h		
56	38	1						
57	39	1	unsigned int	Distance error		03h		
58	3A	1	unsigned int	Output alarm status for analog output		03h	06h	4:21.5mA 6:38.5mA 8:HoldLastValue
59	3B	1	unsigned int	Relay RL1 status		03h		0: off 1:on
60	3C	1	unsigned int	Relay RL2 status		03h		0: off 1:on
65	41	1	unsigned int	F_WINDOW value		03h	06h	0: filters disabled
69	45	1	unsigned int	Setpoint threshold RL1 (Distance from sensor)	mm	03h	06h	
70	46	1	unsigned int	Setpoint threshold RL2 (Distance from sensor)	mm	03h	06h	
71	47	1	unsigned int	UPPER Setpoint pump RL1 (Distance from sensor)	mm	03h	06h	
72	48	1	unsigned int	LOWER Setpoint pump RL1 (Distance from sensor)	mm	03h	06h	
73	49	1	unsigned int	Modbus RS485 Parity		03h	06h	0:NoParity 1:Even 2:Odd

8-OPERATOR INTERFACE

8.1 VL601 FEATURES

The VL601 program module has 4 buttons which allow to perform all operational, control and programming instrument functions. In the configuration menus, is possible:

1. Submenus and parameters access; press  to select and press  to access.
2. Parameter options choice: Press  to select the option and press  to store the option.
Press  to exit without storing.
3. Configure the parameter values; in some parameters the configuration is done by setting a value (eg., in the SET DISTANCE 4mA parameter is possible to change the the corresponding distance value, in mm):
press  to select the digit to be modified (the digit is highlighted in inverse), press  to change the high lighted digits number, press  to save the set value and exit automatically.
Press  to exit without storing.

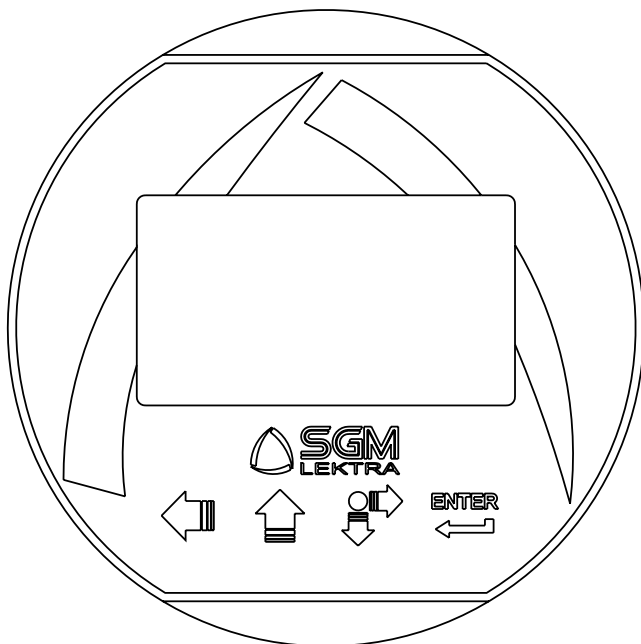

LEFT ARROW button:

- Exit configuration
- Back to previous menu



UP ARROW button:

- Parameter values modification
- Parameter scroll



SCROLL button:

- Cursor movement (to the right)
- Parameter scroll



ENTER button:

- Configuration access
- Options confirmation
- Parameters values confirmation

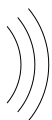

Displayed at the bottom indicates the correct echo signal reception



Displayed at the top alerts that there is a generic error; press SCROLL to show the message that indicates the present error type.

The RPL75 returns automatically to RUN mode.

QUICK SETUP - Menu with easy access for quick basic parameters configuration.

To access: from "RUN" mode press ENTER to the quick setup menu mode access, LEFT ARROW to exit.

ADVANCED SETUP - Full menu with access to all parameters, including functional parameters.

It is recommended to carefully read the complete documentation before accessing.

To access: from "RUN" mode, holding down UP ARROW, press ENTER to the advanced configuration mode access, LEFT ARROW to exit

9-QUICK SETUP

9.1 - Quick Setup menu structure

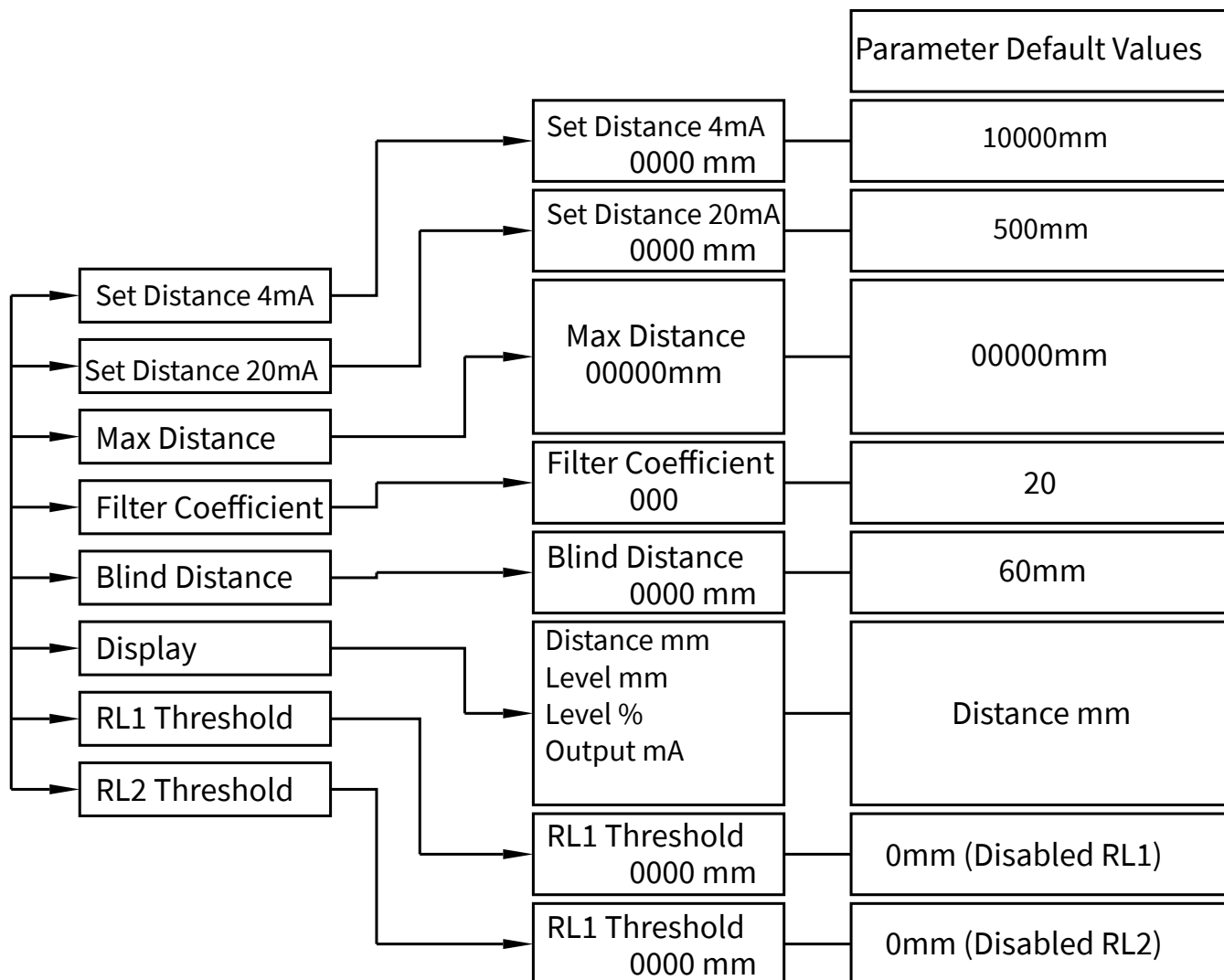

9.2 - QUICK SETUP MODE

From "RUN" mode press ENTER to access the Quick Setup menu.

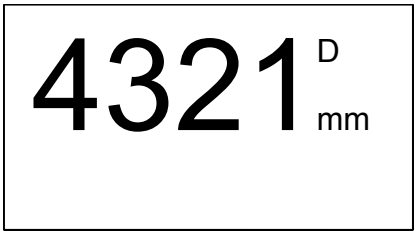

Select the parameters by moving the cursor with SCROLL, and confirm with ENTER; press LEFT ARROW to exit.

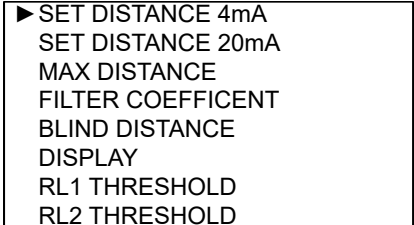

9.2.1 SET DISTANCE 4mA

Press ENTER to display the distance value associated with 4mA output.

Use SCROLL and UP ARROW to modify that value;
in the example the 4mA distance is 3500mm.
Press ENTER to confirm.

```

▶ SET DISTANCE 4mA
  SET DISTANCE 20mA
  MAX DISTANCE
  FILTER COEFFICIENT
  BLIND DISTANCE
  DISPLAY
  RL1 THRESHOLD
  RL2 THRESHOLD
  
```

SET DISTANCE 4mA

3500 mm

9.2.2 SET DISTANCE 20mA

Press ENTER to display the distance value associated with 20mA output.

Use SCROLL and UP ARROW to modify that value;
in the example the 20mA distance is 500mm.
Press ENTER to confirm.

```

  SET DISTANCE 4mA
  ▶ SET DISTANCE 20mA
    MAX DISTANCE
    FILTER COEFFICIENT
    BLIND DISTANCE
    DISPLAY
    RL1 THRESHOLD
    RL2 THRESHOLD
  
```

SET DISTANCE 20mA

0500 mm

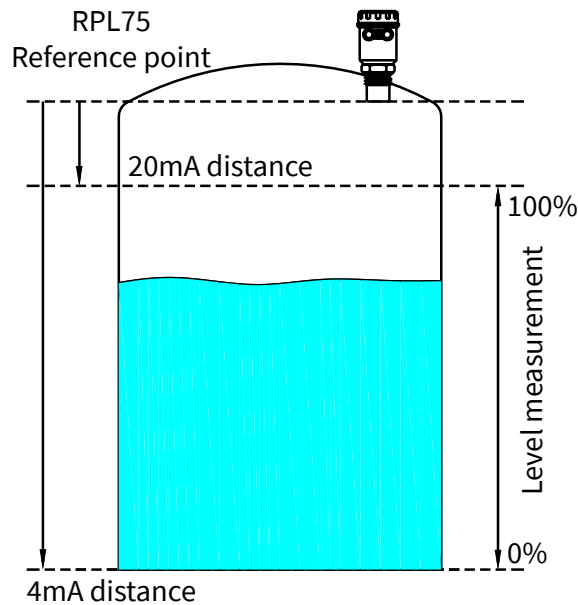

9.2.3 MAX DISTANCE

Press the ENTER key to display the previously set maximum distance value.
The MAX DISTANCE is used to prevent the sensor from detecting an echo signal at a distance .

Use SCROLL and UP ARROW to modify the value; in the example, the maximum measurement distance is 3600mm.

The function is disabled with the value set to 00000mm.

To confirm press ENTER.

SET DISTANCE 4mA SET DISTANCE 20mA ► MAX DISTANCE FILTER COEFFICIENT BLIND DISTANCE DISPLAY RL1 THRESHOLD RL2 THRESHOLD
--

MAX DISTANCE 00000 mm

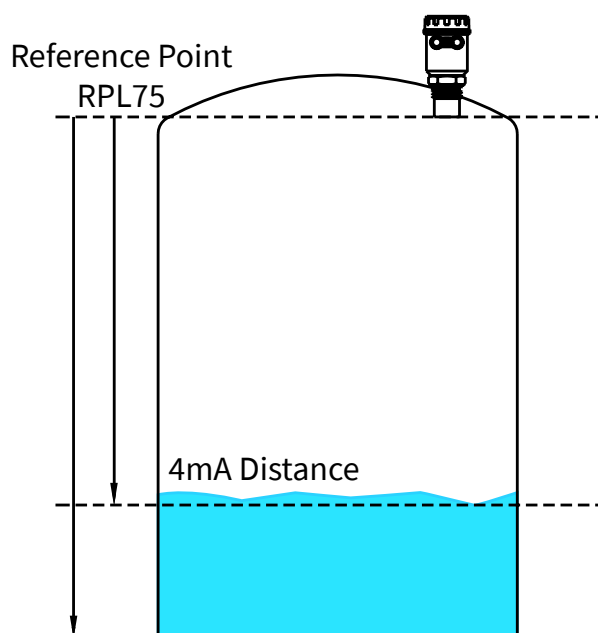

9.2.4 FILTER COEFFICIENT

Press ENTER.

Use SCROLL and UP ARROW to modify the value.

Input a value from 1 to 99.

1 maximum speed, 99 maximum slowness.

The function is deactivated with 0 (immediate response).

Press ENTER to confirm

SET DISTANCE 4mA SET DISTANCE 20mA MAX DISTANCE ► FILTER COEFFICIENT BLIND DISTANCE DISPLAY RL1 THRESHOLD RL2 THRESHOLD
--

FILTER COEFFICIENT

20

Fast resp. 5÷10

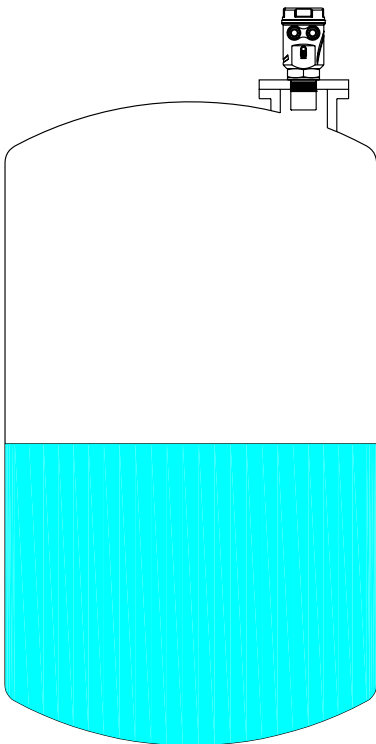

Normal resp. 20

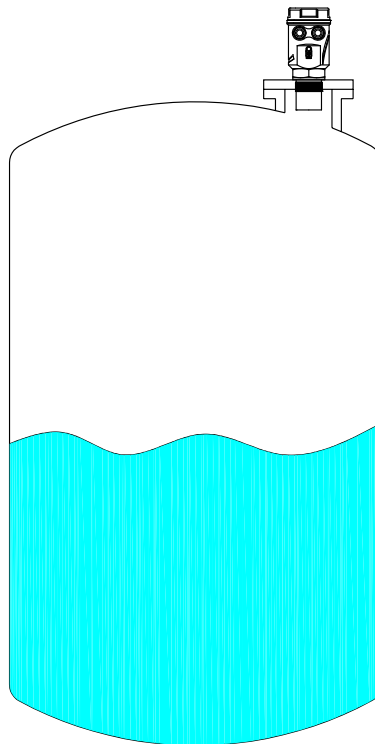

Slow resp. 40÷100

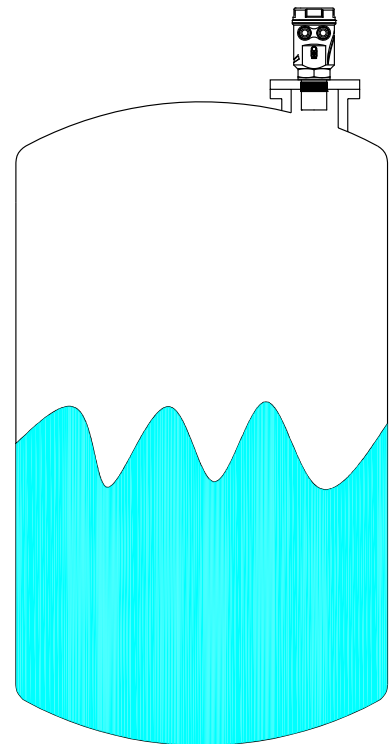

9.2.5 BLIND DISTANCE

Press ENTER.

The BLIND ZONE is used to avoid undesired measures near the transmitter.

Use SCROLL and UP ARROW to modify the value.

Press ENTER to confirm.

The minimum value is 0050mm.

SET DISTANCE 4mA SET DISTANCE 20mA MAX DISTANCE FILTER COEFFICIENT ► BLIND DISTANCE DISPLAY RL1 THRESHOLD RL2 THRESHOLD
--

BLIND DISTANCE 0050 mm

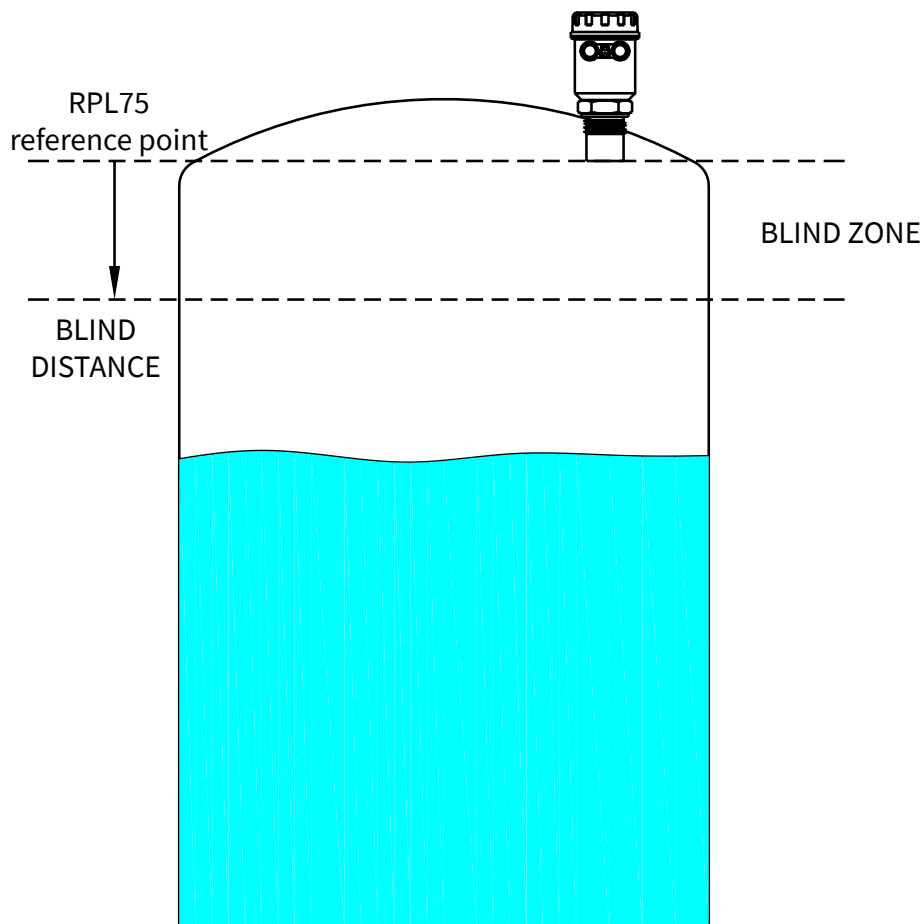

9.2.6 DISPLAY

Press ENTER to access the settings change.

With the SCROLL button is possible to select the data to display.

Press ENTER to confirm.

SET DISTANCE 4mA SET DISTANCE 20mA MAX DISTANCE FILTER COEFFICIENT BLIND DISTANCE ► DISPLAY RL1 THRESHOLD RL2 THRESHOLD
--

► DISTANCE mm LEVEL mm LEVEL % OUTPUT mA

9.2.7 RL1 THRESHOLD

Press ENTER to display the previous setting.
Set the distance from the sensor.

Use SCROLL and UP ARROW to modify the value;
in the example the RL1 max. level threshold distance is 700mm.
Press ENTER to confirm.

NB - RL1 inactive with 0000mm

SET DISTANCE 4mA
SET DISTANCE 20mA
MAX DISTANCE
FILTER COEFFICIENT
BLIND DISTANCE
DISPLAY
▶ RL1 THRESHOLD
RL2 THRESHOLD

RL1 THRESHOLD
0700 mm

When confirming with the ENTER button the maximum level threshold value storage, in the example 3000mm the PL75 activates RL2 with the following default settings for level alarm threshold:

- 1) MIN / MAX = MIN; minimum distance alarm.
- 2) DELAY = 0 sec.; no switching delay.
- 3) SECURITY = YES; relay de-energized, and contact open, during the maximum level alarm.
- 4) ENABLE / DISABLE = ENABLE; alarm threshold function enabled.
- 5) MIN/MAX HYSTERESIS mm = 40mm.

To change these relay setting it is necessary to access the advanced setup menu and any subsequent changes to the RL1 threshold value will not affect the relay custom settings.

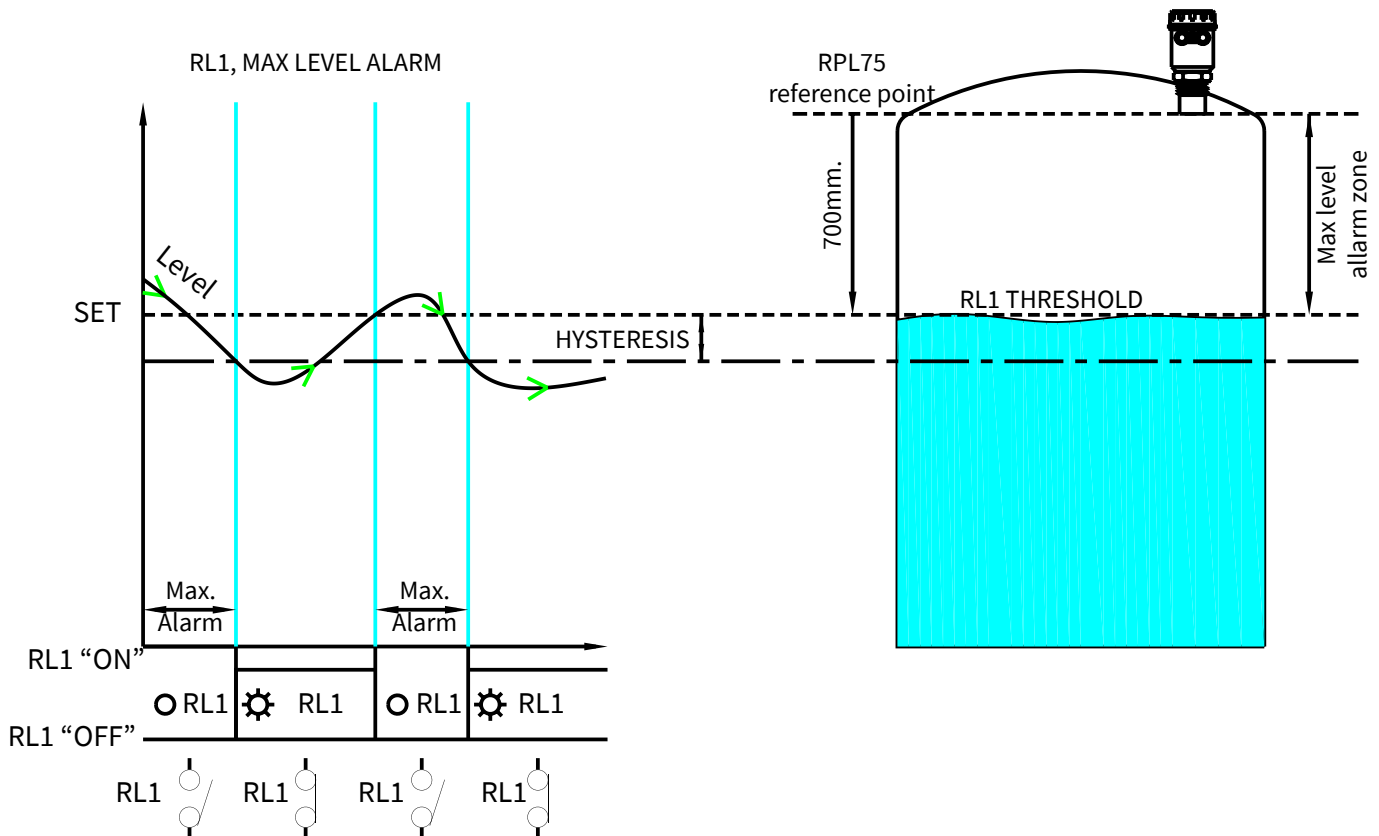

9.2.8 RL2 THRESHOLD

Press ENTER to display the previous setting.
Set the distance from the sensor.

Use SCROLL and UP ARROW to modify the value; in the example the RL2 min. level threshold distance is 3000mm.
Press ENTER to confirm.

NB - RL2 inactive with 0000mm

SET DISTANCE 4mA SET DISTANCE 20mA MAX DISTANCE FILTER COEFFICIENT BLIND DISTANCE DISPLAY RL1 THRESHOLD ► RL2 THRESHOLD
RL2 THRESHOLD 3000 mm

When confirming with the ENTER button the maximum level threshold value storage, in the example 3000mm, the RPL75 activates RL2 with the following default settings for level alarm threshold:

- 1) MIN / MAX = MAX; maximum distance alarm.
- 2) DELAY = 0 sec.; no switching delay.
- 3) SECURITY = YES; relay de-energized, and contact open, during the maximum level alarm.
- 4) ENABLE / DISABLE = ENABLE; alarm threshold function enabled.
- 5) MIN/MAX HYSTERESIS mm = 40mm.

To change these relay settings it is necessary to access the advanced setup menu and any subsequent changes to the RL2 threshold value will not affect the relay custom settings.

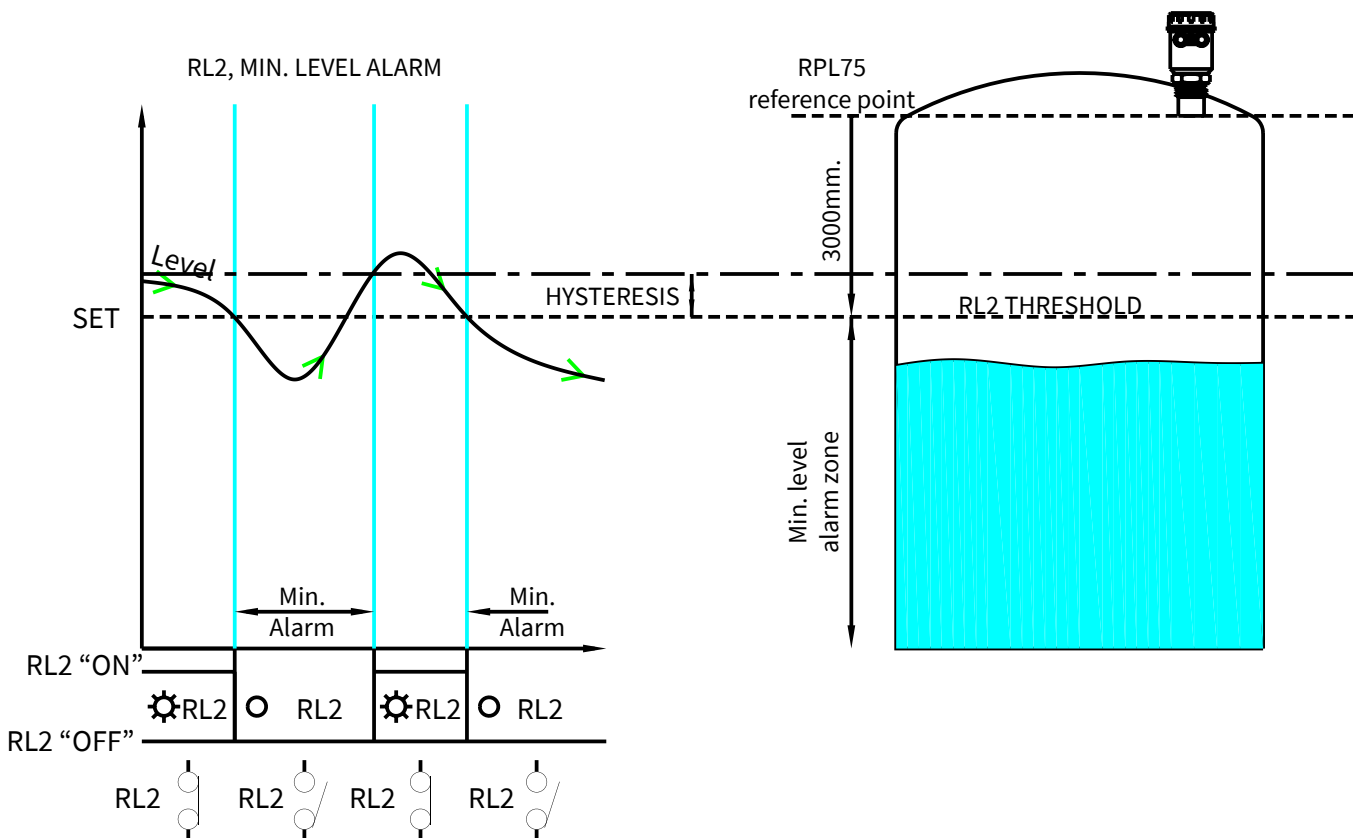

10-ADVANCED CONFIGURATION

10.1 - "SETUP" MENU

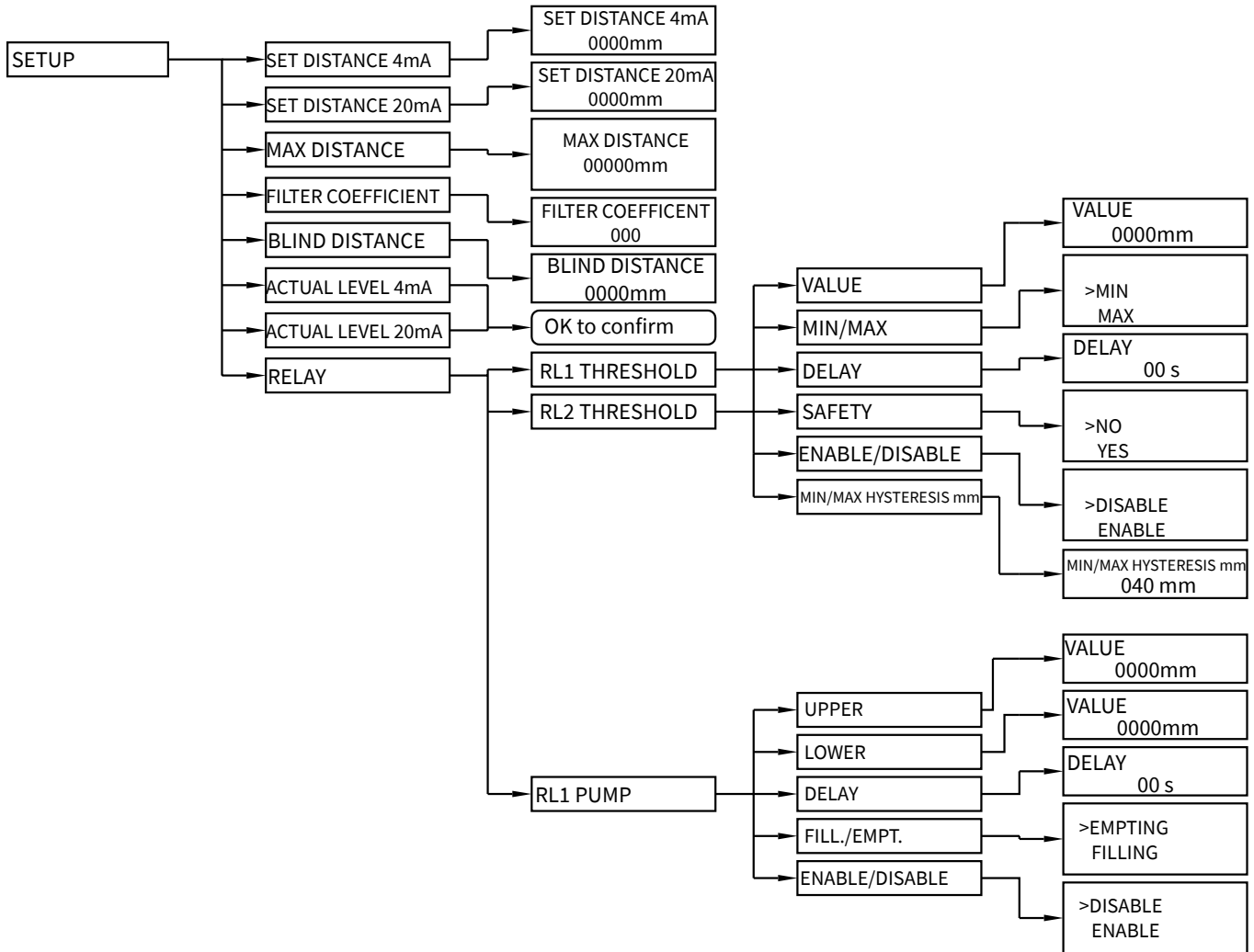

10.2 - SETUP

From "RUN" mode, holding down UP ARROW, press ENTER to the advanced setup mode access.

Press SCROLL to select the menu and press ENTER to access.
Press LEFT ARROW to exit.

4321^D mm

- ▶ SETUP
- DISPLAY
- DIAGNOSTIC
- SERVICE
- INFO

- ▶ SET DISTANCE 4mA
- SET DISTANCE 20mA
- MAX DISTANCE
- FILTER COEFFICIENT
- BLIND DISTANCE
- ACTUAL LEV. 4mA
- ACTUAL LEV. 20mA
- RELAYS

10.2.1 - SET DISTANCE 4mA

Position the cursor on DISTANCE 4mA, press ENTER to access.

Use UP ARROW and SCROLL to modify the value.
Press ENTER to confirm.
LEFT ARROW to exit without changes.

Default value: 10000mm.

► SET DISTANCE 4mA
SET DISTANCE 20mA
MAX DISTANCE
FILTER COEFFICIENT
BLIND DISTANCE
ACTUAL LEV. 4mA
ACTUAL LEV. 20mA
RELAYS

SET DISTANCE 4mA

10000 mm

10.2.2 - SET DISTANCE 20mA

Position the cursor on DISTANCE 20mA, press ENTER to access.

Use UP ARROW and SCROLL to modify the value.
Press ENTER to confirm.
LEFT ARROW to exit without changes.

Default value: 500mm

SET DISTANCE 4mA
► SET DISTANCE 20mA
MAX DISTANCE
FILTER COEFFICIENT
BLIND DISTANCE
ACTUAL LEV. 4mA
ACTUAL LEV. 20mA
RELAYS

SET DISTANCE 20mA

500 mm

10.2.3 - MAX DISTANCE

Press the ENTER key to display the previously set maximum distance value.
The MAX DISTANCE is used to prevent the sensor from detecting an echo signal at a distance outside its maximum application distance (eg tank bottom).

Use SCROLL and UP ARROW to modify the value;
in the example, the maximum measurement distance is 3600mm.

The function is disabled with the value set to 00000mm.
To confirm press ENTER.
Default value: 00000mm.

SET DISTANCE 4mA
SET DISTANCE 20mA
► MAX DISTANCE
FILTER COEFFICIENT
BLIND DISTANCE
ACTUAL LEV. 4mA
ACTUAL LEV. 20mA
RELAYS

MAX DISTANCE

00000 mm

10.2.4 - FILTER COEFFICIENT

Position the cursor on FILTER COEFFICIENT, press ENTER to access.

Enter a value from 1 to 99: 1 maximum speed, 99 maximum slowness.
The function is deactivated with 0 (immediate response).
Use UP ARROW and SCROLL to modify the value.
Press ENTER to confirm.
LEFT ARROW to exit without changes.

Default value: 20

SET DISTANCE 4mA
SET DISTANCE 20mA
MAX DISTANCE
► FILTER COEFFICIENT
BLIND DISTANCE
ACTUAL LEV. 4mA
ACTUAL LEV. 20mA
RELAYS

FILTER COEFFICIENT

20

10.2.5 - BLIND DISTANCE

Position the cursor on DISTANCE 4mA, press ENTER to access.
Represent the "BLIND ZONE".

Input the desired value in order to avoid measures near the surface of the sensor (if necessary).

The minimum value is 0050mm.

Use UP ARROW and SCROLL to modify the value.

Press ENTER to confirm.

LEFT ARROW to exit without changes .

Default values: 60mm

```

SET DISTANCE 4mA
SET DISTANCE 20mA
MAX DISTANCE
FILTER COEFFICIENT
▶ BLIND DISTANCE
ACTUAL LEV. 4mA
ACTUAL LEV. 20mA
RELAYS

```

```

BLIND DISTANCE

60 mm

```

10.2.6 - ACTUAL LEV. 4mA

Position the cursor on ACTUAL LEV. 4mA, press ENTER to access.

Self distance learning function that is associated with the 4mA (lower value).

Make sure that the level corresponds to 0%, ENTER to associate the actual measure with 4mA output value;

OK TO CONFIRM.

LEFT ARROW to exit without changes.

```

SET DISTANCE 4mA
SET DISTANCE 20mA
MAX DISTANCE
FILTER COEFFICIENT
BLIND DISTANCE
▶ ACTUAL LEV. 4mA
ACTUAL LEV. 20mA
RELAYS

```

10.2.7 - ACTUAL LEV. 20mA

Position the cursor on ACTUAL LEV. 20mA, press ENTER to access.

Self distance learning function that is associated with the 20mA (upper value).

Make sure that the level corresponds to 100%, ENTER to associate the actual measure with 20mA output value;

OK TO CONFIRM .

LEFT ARROW to exit without changes.

```

SET DISTANCE 4mA
SET DISTANCE 20mA
MAX DISTANCE
FILTER COEFFICIENT
BLIND DISTANCE
ACTUAL LEV. 4mA
▶ ACTUAL LEV. 20mA
RELAYS

```

10.2.8 - RELAYS

Position the cursor on RELAYS, press ENTER to access.

```

SET DISTANCE 4mA
SET DISTANCE 20mA
MAX DISTANCE
FILTER COEFFICIENT
BLIND DISTANCE
ACTUAL LEV. 4mA
ACTUAL LEV. 20mA
▶ RELAYS
  
```

In this sub-menù it's possible to setup onboard relays
 RL1 can be set as threshold relay or pump-control relay;
 RL2 can be set as threshold relay or diagnostic relay.
 With the SCROLL button you can select the operation mode,
 then pressing ENTER to confirm the selection

```

▶ RL1 THRESHOLD
  RL2 THRESHOLD
  RL1 PUMP
  
```

10.2.8.1 - RL1 THRESHOLD (RL2 THRESHOLD equivalent)

Position the cursor on RL1 THRESHOLD, press ENTER to access.

```

▶ RL1 THRESHOLD
  RL2 THRESHOLD
  RL1 PUMP
  
```

In this submenu you can set the set-point and the relay 1 and 2
 action type.
 With the SCROLL button you can select the parameter to be programmed.
 Press ENTER to confirm

```

▶ VALUE
  MIN/MAX
  DELAY
  SAFETY
  ANABLE/DISABLE
  MIN/MAX HYSTERESIS
  
```

10.2.8.1.1 - VALUE

Position the cursor on VALUE, press ENTER to access.

It's possible to input the threshold value that corresponds to the
 distance in mm from the sensor.
 Use UP ARROW and SCROLL to modify the value.
 Press ENTER to confirm.
 LEFT ARROW to exit without changes.

```

▶ VALUE
  MIN/MAX
  DELAY
  SAFETY
  ANABLE/DISABLE
  MIN/MAX HYSTERESIS
  
```

Default value: 0000mm
 NB-RL1/2 inactive with 0000mm

```

VALUE
1000 mm
  
```

10.2.8.1.2 - MIN/MAX

Position the cursor on VALUE, press ENTER to access.

It's possible to select if the relay works as maximum level threshold or
 minimum level threshold.
 With the SCROLL button you can select the operation mode.
 Press ENTER to confirm.
 LEFT ARROW to exit without changes.

```

VALUE
▶ MIN/MAX
  DELAY
  SAFETY
  ANABLE/DISABLE
  MIN/MAX HYSTERESIS
  
```

Default value: MAX for RL1; MIN for RL2

```

MIN
▶ MAX
  
```

10.2.8.1.3 - DELAY

Position the cursor on DELAY, press ENTER to access.

It's possible to set the activation delay for the selected relay, from 0 to 99 sec.
Use UP ARROW and SCROLL to modify the value.
Press ENTER to confirm.
LEFT ARROW to exit without changes

Default value: 00s

VALUE
MIN/MAX
▶ DELAY
SAFETY
ANABLE/DISABLE
MIN/MAX HYSTERESIS

DELAY

00 s

10.2.8.1.4 - SAFETY

Position the cursor on SAFETY, press ENTER to access.

A "safety alarm" provides a "closed" contact with relay energized in normal condition (no alarm), the contact switches to "open":

- Alarm condition (eg overcoming MAX);
- In power failure case.

With the SCROLL button you can select the alarm mode.

Press ENTER to confirm.

LEFT ARROW to exit without changes.

Default value: YES

VALUE
MIN/MAX
DELAY
▶ SAFETY
ANABLE/DISABLE
MIN/MAX HYSTERESIS

NO
▶ YES

10.2.8.1.5 - ENABLE/DISABLE

Position the cursor on ENABLE/DISABLE, press ENTER to access.

Select ENABLE to activate relay threshold.

Select DISABLE to not activate relay threshold.

With the SCROLL button you can select the operation mode.

Press ENTER to confirm.

LEFT ARROW to exit without changes.

Default value: DISABLE

VALUE
MIN/MAX
DELAY
SAFETY
▶ ANABLE/DISABLE
MIN/MAX HYSTERESIS

DISABLE
▶ ENABLE

10.2.8.1.6 - MIN/MAX HYSTERESIS mm

Position the cursor on MIN/MAX HYSTERESIS mm, press ENTER to access.

It's possible to input the threshold hysteresis.

Use UP ARROW and SCROLL to modify the value.

Press ENTER to confirm.

LEFT ARROW to exit without changes.

Default value: 40mm

VALUE
MIN/MAX
DELAY
SAFETY
ANABLE/DISABLE
▶ MIN/MAX HYSTERESIS

MIN/MAX HYSTERESIS mm

040 mm

10.2.8.2 - RL1 PUMP (only for RL1)

Position the cursor on RL1 PUMP, press ENTER to access

A pump control functioning activation, with hysteresis, is possible two thresholds setting is required: upper and lower threshold.
 upper and lower threshold.
 With the SCROLL button you can select the parameter to be programmed.
 Press ENTER to confirm.

10.2.8.2.1 - UPPER

Position the cursor on UPPER, press ENTER to access.
 The upper threshold is expressed in mm distance from the sensor.
 Represents the pump starting point, EMPTY case, or pump stopping point, FILLING case.

Use UP ARROW and SCROLL to modify the value.
 Press ENTER to confirm.
 LEFT ARROW to exit without changes.

Default value: 0

10.2.8.2.2 - LOWER

Position the cursor on LOWER, press ENTER to access.
 The lower threshold is expressed in mm distance from the sensor.
 Represents the pump stopping point, EMPTY case, or pump starting point, FILLING case.

Use UP ARROW and SCROLL to modify the value.
 Press ENTER to confirm.
 LEFT ARROW to exit without changes.

Default value: 0

RL1 THRESHOLD RL2 THRESHOLD ► RL1 PUMP
► UPPER LOWER DELAY FILL./EMPT. ENABLE/DISABLE
► UPPER LOWER DELAY FILL./EMPT. ENABLE/DISABLE
VALUE <h1>0900 mm</h1>
UPPER ► LOWER DELAY FILL./EMPT. ENABLE/DISABLE
VALUE <h1>4000 mm</h1>

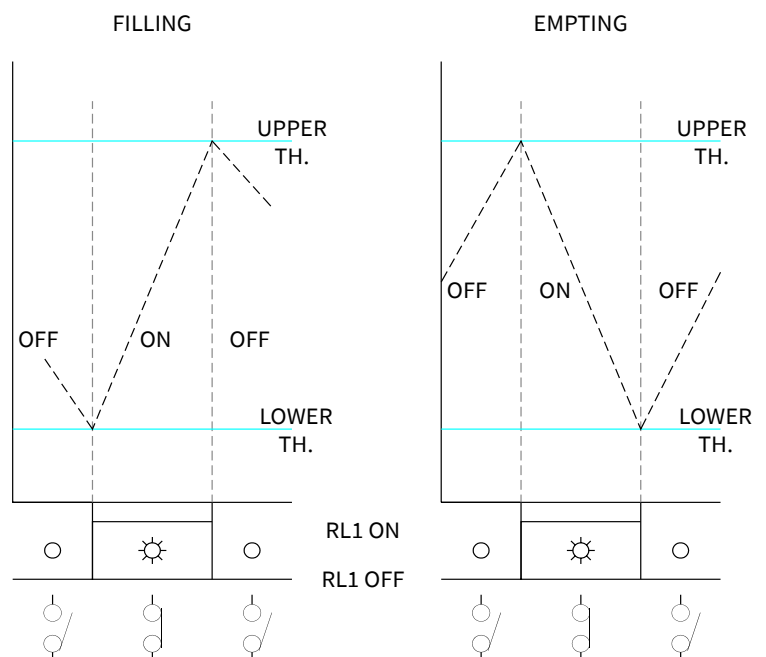
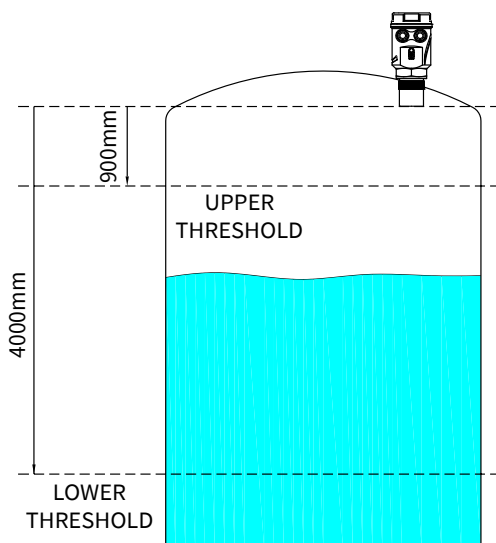

10.2.8.2.3 - DELAY

Position the cursor on DELAY, press ENTER to access.

Set the relay delay activation, from 0 to 99 sec.
Use UP ARROW and SCROLL to modify the value.
Press ENTER to confirm.
LEFT ARROW to exit without changes.

Default value: 0

10.2.8.2.4 - FILL./EMPT

Position the cursor on DELAY, press ENTER to access.

it's possible to select the mode of pump control (FILLING or EMPTING).
With the SCROLL button you can select the operation mode.
Press ENTER to confirm.
LEFT ARROW to exit without changes.

Default value: EMPTING

10.2.8.2.5 - ENABLE/DISABLE

Position the cursor on ENABLE/DISABLE, press ENTER to access.

Select ENABLE to activate relay threshold.
Select DISABLE to not activate relay threshold.
With the SCROLL button you can select the operation mode.
Press ENTER to confirm.
LEFT ARROW to exit without changes.

Default value: DISABLE

```
UPPER
LOWER
▶ DELAY
FILL./EMPT.
ENABLE/DISABLE
```

DELAY

05 s

```
UPPER
LOWER
DELAY
▶ FILL./EMPT.
ENABLE/DISABLE
```

```
▶ EMPTING
FILLING
```

```
UPPER
LOWER
DELAY
FILL./EMPT.
▶ ENABLE/DISABLE
```

```
▶ DISABLE
ENABLE
```

10.3 “DISPLAY” menu

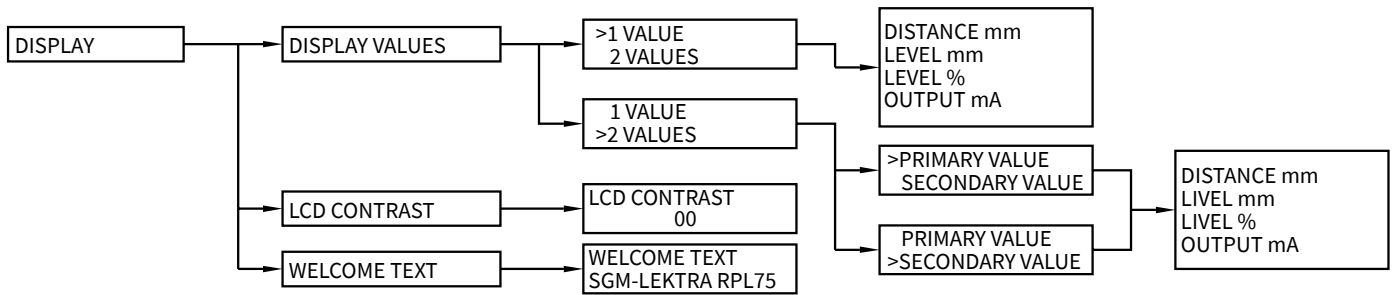

10.4 - DISPLAY

From “RUN” mode, holding down UP ARROW, press ENTER to access. Position the cursor on DISPLAY and press ENTER.

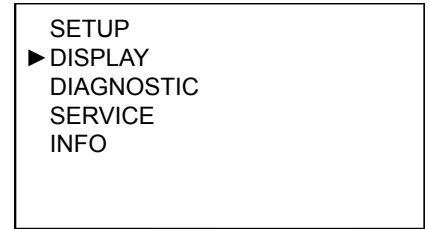

Select the parameters by moving the cursor with SCROLL and confirm with ENTER

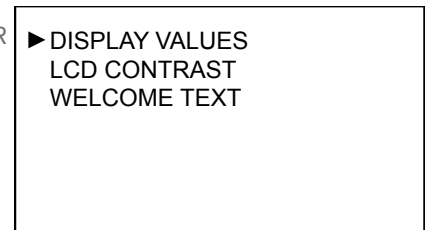

10.4.1 - DISPLAY VALUES

Position the cursor on DISPLAY VALUES, press ENTER to access.

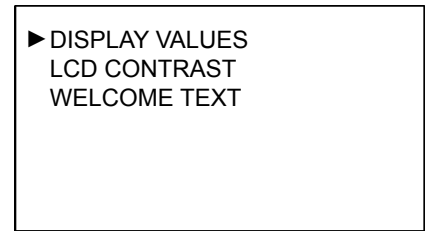

It’s possible to select if one value with big digits or two values are shown on the display in “RUN” mode. Select the parameters by moving the cursor with SCROLL and confirm with ENTER. LEFT ARROW to exit without changes.

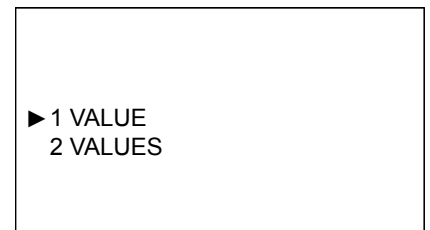

10.4.1.1 - 1 VALUE

Position the cursor on 1 VALUE, press ENTER to access.

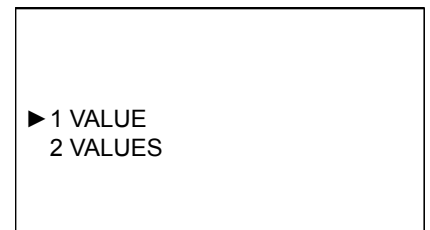

Only one value is displayed; it’s possible to choose from 4 parameters. With the SCROLL button you can select data to display. Press ENTER to confirm. LEFT ARROW to exit without changes.

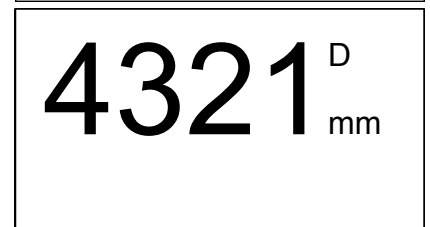
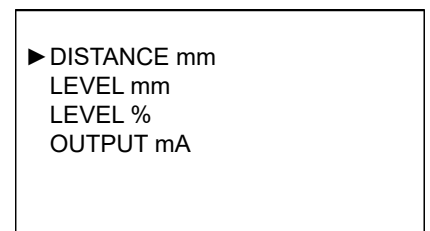

10.4.1.2 - 2 VALUE

Position the cursor on 2 VALUE, press ENTER to access.

Two values are displayed; it's possible to choose which one is the primary and which is the secondary, each with a choice of 4 parameters. With the SCROLL button you can select data to display. Press ENTER to confirm. LEFT ARROW to exit without changes.

```

1 VALUE
▶ 2 VALUES

```

```

▶ PRIMARY VALUE
  SECONDARY VALUE

```

```

▶ DISTANCE mm
  LEVEL mm
  LEVEL %
  OUTPUT mA

```

```

PRIMARY VALUE
▶ SECONDARY VALUE

```

```

DISTANCE mm
▶ LEVEL mm
  LEVEL %
  OUTPUT mA

```

10.4.2 - LCD CONTRAST

Position the cursor on LCD CONTRAST, press ENTER to access.

it's possible to adjust the contrast of LCD, simply increasing or decreasing the value of a parameter from 0 to 63. Use UP ARROW and SCROLL to modify the value. Press ENTER to confirm. LEFT ARROW to exit without changes.

Default value: 22

10.4.3 - WELCOME TEXT

Position the cursor on WELCOME TEXT, press ENTER to access.

It's possible to edit or delete the message that is displayed by the RPL75 during the ignition phase.

Use UP ARROW (up scroll) and SCROLL (down scroll) to change the digit; ENTER to move the digit to the right. To confirm press ENTER repeatedly until leave the parameter. LEFT ARROW to exit without changes.

Default value: SGM-LEKTRA RPL75

```

DISPLAY VALUES
▶ LCD CONTRAST
  WELCOME TEXT

```

```

LCD CONTRAST

22

```

```

DISPLAY VALUES
LCD CONTRAST
▶ WELCOME TEXT

```

```

WELCOME TEXT

SGM-LEKTRA
RPL75

```

10.5 “DIAGNOSTIC” menu

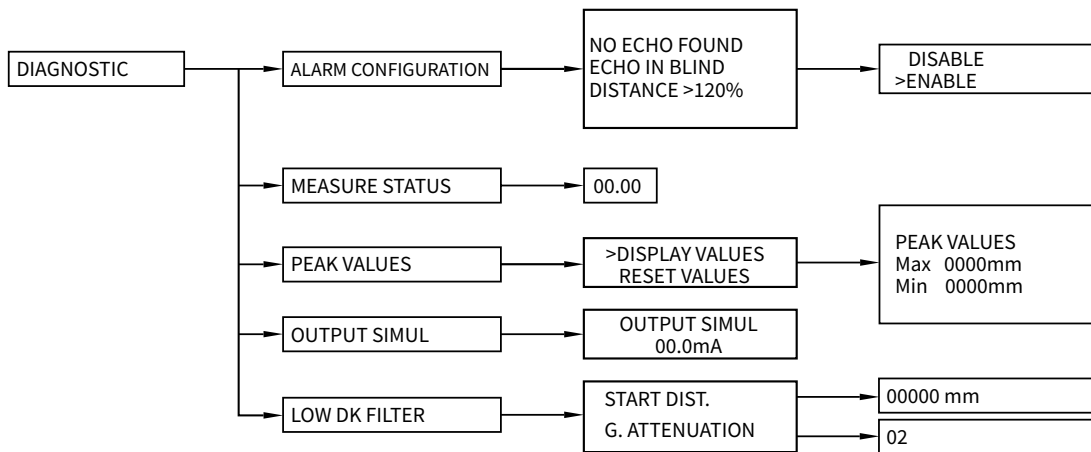

10.6 - DIAGNOSTIC

From “RUN” mode, holding down UP ARROW, press ENTER to access. Position the cursor on DIAGNOSTIC and press ENTER.

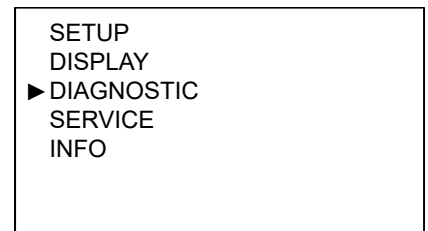

Select the parameters by moving the cursor with SCROLL and confirm with ENTER

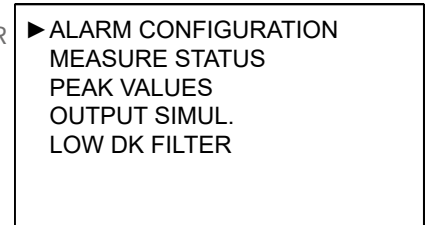

10.6.1 - ALARM CONFIGURATION

Position the cursor on ALARM CONFIGURATION, press ENTER to access.

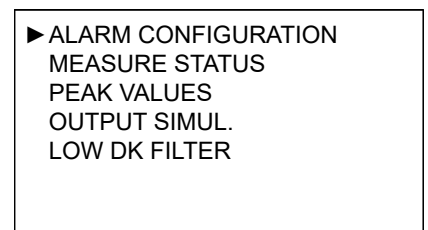

To enable or disable each diagnostic alarms.

- With UP ARROW or SCROLL chose the desired item and press ENTER.

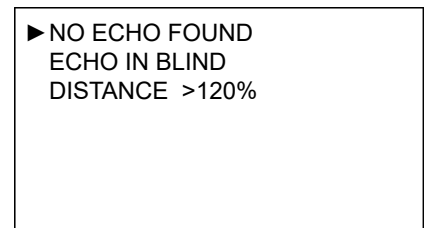

- With UP ARROW or SCROLL enable or disable the alarm signal and press ENTER to confirm

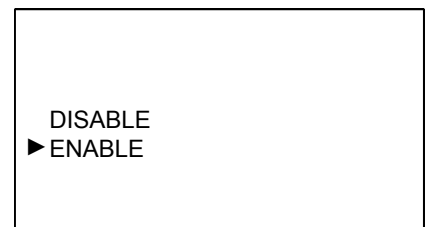

10.6.2 - MEASURE STATUS

Position the cursor on MEASURE STATUS, press ENTER to access.

It's possible to display a value proportional to the goodness of the installation.
During installation search for the maximum value.
LEFT ARROW to exit

10.6.3 - PEAK VALUES

Position the cursor on PEAK VALUES, press ENTER to access.

The system store the maximum distance and the minimum distance measured since the power is turned ON.
It's possible to see those values or reset the values.
With the SCROLL button you can select the function.
Press ENTER to confirm.

10.6.3.1 - DISPLAY VALUES

Position the cursor on DISPLAY VALUES, press ENTER to access.

Displays the max. and min. distance measured from power on.
LEFT ARROW to exit.
NB - The peak values stored are erased every time the RPL75 turns-off

10.6.3.2 - RESET VALUES

Position the cursor on RESET VALUES, press ENTER to access.

LEFT ARROW to return to the previous menu

10.6.4 - OUTPUT SIMULATION

WARNING - entering in the SIMULATION function, the current output is not in function of the level measurement.
To restore the current as a measured level function, press the LEFT ARROW button 3 times (RUN mode).

Position the cursor on OUTPUT SIMULATION, press ENTER to access.

It's possible to force the analog output to a desired value, from 3,5 to 21mA.
Use UP ARROW and SCROLL to modify the value.
LEFT ARROW to return to the previous menu.

```
ALARM CONFIGURATION
▶ MEASURE STATUS
  PEAK VALUES
  OUTPUT SIMUL.
  LOW DK FILTER
```

```
MEASURE STATUS

G: 00000
```

```
ALARM CONFIGURATION
MEASURE STATUS
▶ PEAK VALUES
  OUTPUT SIMUL.
  LOW DK FILTER
```

```
▶ DISPLAY VALUES

RESET VALUES
```

```
▶ DISPLAY VALUES

RESET VALUES
```

```
PEAK VALUES

MAX   0000mm
MIN   0000mm
```

```
DISPLAY VALUES
▶ RESET VALUES
```

```
ALARM CONFIGURATION
MEASURE STATUS
PEAK VALUES
▶ OUTPUT SIMUL.
  LOW DK FILTER
```

```
OUTPUT SIMUL.

04.0mA
```

10.6.5 - LOW DK FILTER

In level measurement applications with products having a low dielectric constant value (e.g. oils), the radar pulses can pass through the product and reflect on the bottom of the tank.

“LOW DK FILTER” has the function of attenuating any echo signals reflected from the bottom of the tank to prevent them, under certain conditions, from being acquired as an incorrect empty tank level measurement.

You can enable or disable the “LOW DK FILTER” function.
Place the cursor on LOW DK FILTER and press ENTER to enter.

10.6.5.1 - START DIST.

Position cursor on START DIST. and press ENTER.

It is possible to set the distance from the RPL sensor beyond which the attenuation of the received echo signals is activated.

By setting 00000mm the LOW DK FILTER function is disabled.

Setting 25000mm START DIST. is in dynamic mode; in this case the activation distance will correspond to the distance of the first echo signal generated by the target and will change dynamically according to the target’s movement.

Use UP ARROW and SCROLL to modify the value.

Press ENTER to confirm.

LEFT ARROW to exit without changes

Default value: 0000mm

10.6.5.2 - G. ATTENUATION

Place the cursor on G. ATTENUATION and press ENTER.

It is possible to set the efficiency attenuation factor of the echo signals detected at a distance greater than the value set in the START DIST. parameter.

Use UP ARROW and SCROLL to modify the value.

Press ENTER to confirm.

LEFT ARROW to exit without changes.

Default value: 0000mm.

```
ALARM CONFIGURATION
MEASURE STATUS
PEAK VALUES
OUTPUT SIMUL.
▶ LOW DK FILTER
```

```
▶ START DIST.
  G. ATTENUATION
```

```
START DIST.

00000 mm
```

```
START DIST.
▶ G. ATTENUATION
```

```
G. ATTENUATION

02
```

10.7 "SERVICE" menu

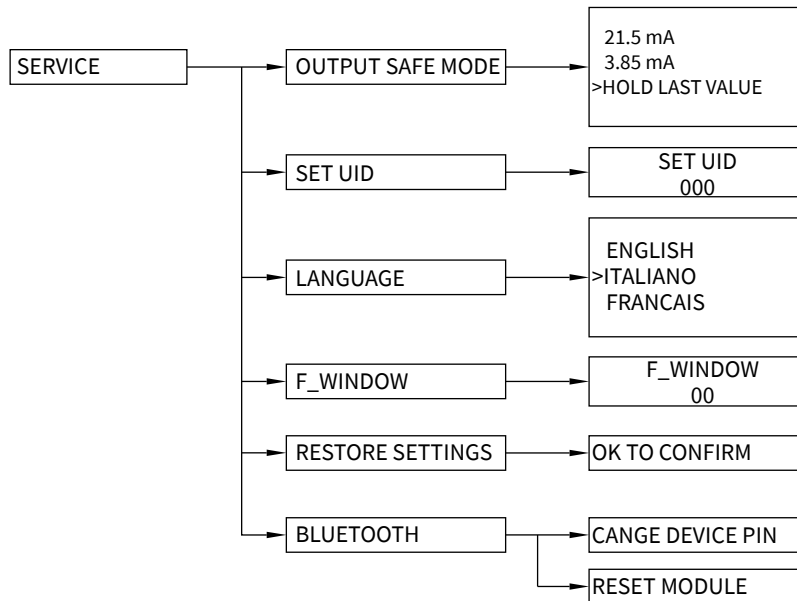

10.8 - SERVICE

From "RUN" mode, holding down UP ARROW, press ENTER to access. Position the cursor on SERVICE and press ENTER.

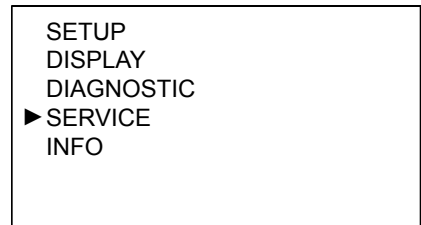

Select the parameters by moving the cursor with SCROLL and confirm with ENTER

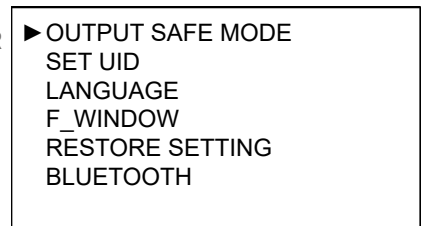

10.8.1 - OUTPUT SAFE MODE

Position the cursor on OUTPUT SAFE MODE, press ENTER to access.

It's possible to choose a analog output value during diagnostic errors.

"21.5 mA" forces the current output to 21,5mA

"3.85 mA" forces the current output to 3,85mA

"HOLD LAST VALUE" maintains the output at the last valid value.

With the SCROLL button you can select the operation mode.

Press ENTER to confirm.

LEFT ARROW to exit without changes.

Default value: HOLD LAST VALUE

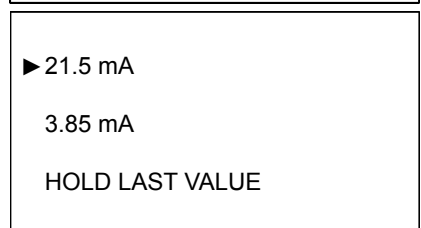
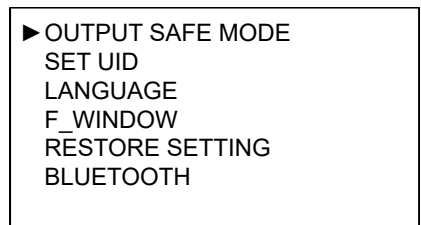

10.8.2 - SET UID

Position the cursor on SET UID, press ENTER to access.

Can assign the address UID in this parameter, for a MUDBUS RTU network.

Use UP ARROW and SCROLL to modify the value.

Press ENTER to confirm.

LEFT ARROW to exit without changes.

Default value 001

```

OUTPUT SAFE MODE
▶ SET UID
LANGUAGE
F_WINDOW
RESTORE SETTING
BLUETOOTH

```

```

SET UID

001

```

10.8.3 - LANGUAGE

Position the cursor on LANGUAGE, press ENTER to access.

Sets the menu language: English, Italian, French

Press SCROLL to select the menu language.

Press ENTER to confirm.

LEFT ARROW to exit without changes.

```

OUTPUT SAFE MODE
SET UID
▶ LANGUAGE
F_WINDOW
RESTORE SETTING
BLUETOOTH

```

```

ENGLISH
▶ ITALIANO
FRANCAIS

```

10.8.4 - F_ WINDOWS

Position the cursor on F_WINDOWS, press ENTER to access.

It is the increasing value (in cm), step to step, of the window width during the echo signal research phase.

The "F_WINDOWS" is the area where the echo reception is active.

Normally it is positioned around the real echo signal and all echoes detected within the F_WINDOW are deemed valid.

Example: F_WINDOW parameter set to 5.

- The RPL75 detects an echo signal which is 4 meters from the sensor.
- Suddenly, the echo signal disappears and a new echo signal to 3.5 mt away from the sensor is detected.
- Each time the echo signal will be emitted, the RPL75 will enlarge "F_WINDOW" with 5cm step, until covering the new eco detected area.

Now the F_WINDOW will start to tighten around the new echo signal and the new measurement of 3,5mt distance will be used to calculate the level measurement, alarm thresholds, etc..

F_WINDOW serves to filter false echo signals caused, for example, by the agitator blades.

Range: 05÷20

Use UP ARROW and SCROLL to modify the value.

Press ENTER to confirm.

LEFT ARROW to exit without changes.

Default value: 05

```

OUTPUT SAFE MODE
SET UID
LANGUAGE
▶ F_WINDOW
RESTORE SETTING
BLUETOOTH

```

```

SET WIDTH

05

```

10.8.5 - RESTORE SETTING

Position the cursor on SET UID, press ENTER to access.

```

OUTPUT SAFE MODE
SET UID
LANGUAGE
F_WINDOW
▶ RESTORE SETTING
BLUETOOTH
  
```

Press ENTER to restore the RPL75 default settings.
LEFT ARROW to exit without restored the RPL75 default settings

```

OK TO CONFIRM
  
```

10.8.6 - BLUETOOTH (OPTIONAL)

Position the cursor on BLUETHOOT, press ENTER to access.
The BLUETOOTH menu is accessible only when RPL75 is equipped with the BLUETOOTH port (opt.)

```

OUTPUT SAFE MODE
SET UID
LANGUAGE
F_WINDOW
RESTORE SETTING
▶ BLUETOOTH
  
```

10.8.6.1 – CHANGE DEVICE PIN

Position the cursor on CHANGE DEVICE PIN, press ENTER to enter.
It's possible to change the security PIN for BLUETOOTH connecting.

```

▶ CHANGE DEVICE PIN
RESET MODULE
  
```

Use UP ARROW and SCROLL to modify the value.
Press ENTER to confirm. LEFT ARROW to exit without changes.
Default value: 1234

```

CHANGE DEVICE PIN
1234
  
```

10.8.6.2 – BT RESET

Position the cursor on RESET MODULE, press ENTER to enter.
It's possible to restore the BLUETOOTH port settings.

```

CHANGE DEVICE PIN
▶ RESET MODULE
  
```

10.9 “INFO” menu

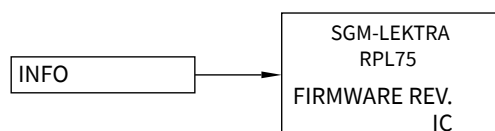

10.9.1 - INFO

Position the cursor on INFO, press ENTER to access.

In addition to information about the manufacturer, are displayed the firmware revision and the configuration index.

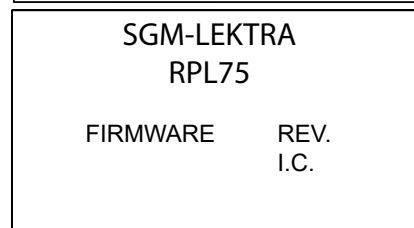
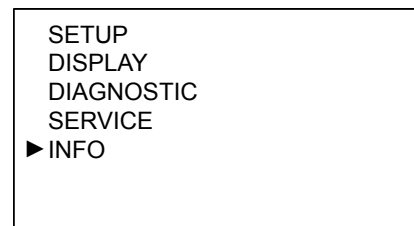

12-FACTORY TEST AND QUALITY CERTIFICATE



In conformity to the company and check procedures I certify that the equipment:

(Radar level transmitter)

is conform to the technical requirements on Technical Data and it is made in conformity to the procedure

Quality Control Manager: Production and check date: